

# PILARES | ESQUINERO

# PILARES | MÉNSULAS

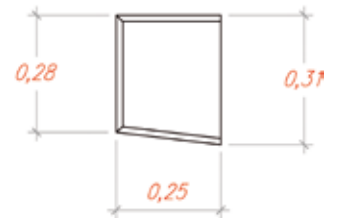

Nota.- Para otras dimensiones consultar con el Dpto. Técnico o Comercial

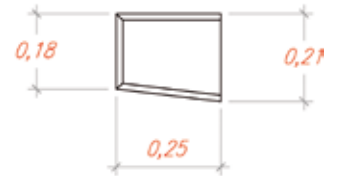
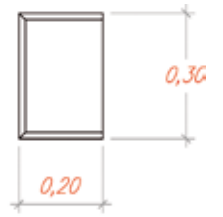
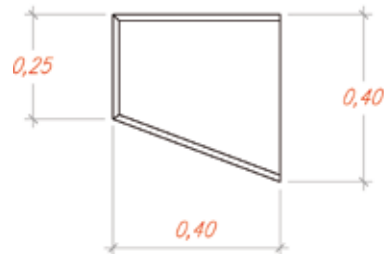
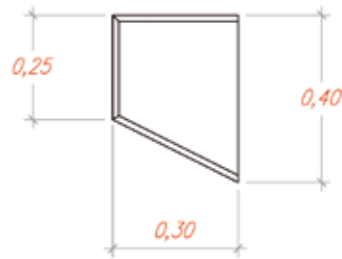
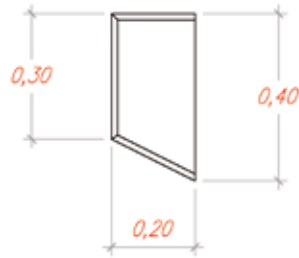
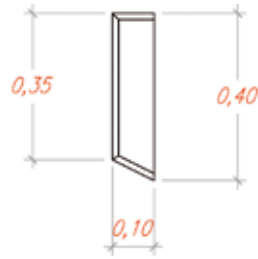
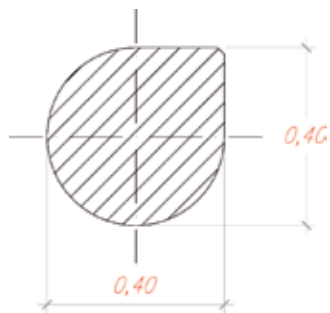

**T**  
**TECNYCONTA.**  
Prefabricados de hormigón

**Oficinas Centrales y Fábrica**

Carretera Gallur-Sangüesa, km. 11  
50660 Tauste | Zaragoza  
Teléfono: (+34) 976 869 750  
Fax: (+34) 976 859 253

**Delegación**

Paseo Independencia 14, 1º izda.  
50004 Zaragoza  
Teléfono: (+34) 976 797 228  
Fax: (+34) 976 797 284

[tecnycnta@tecnycnta.com](mailto:tecnycnta@tecnycnta.com)  
[www.tecnycnta.com](http://www.tecnycnta.com)



Grupo TÜV Rheinland