

PILARES | ESQUINERO

PILARES | MÉNSULAS

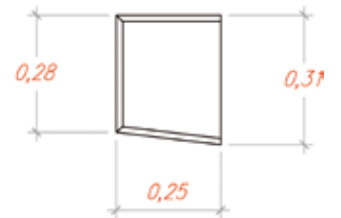

Nota.- Para otras dimensiones consultar con el Dpto. Técnico o Comercial

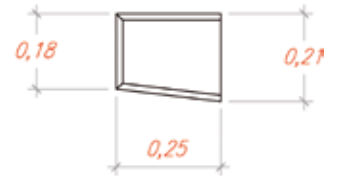
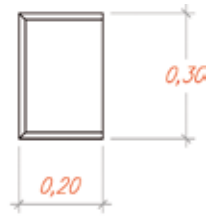
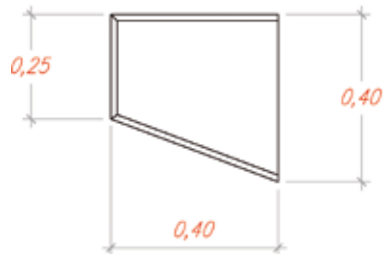
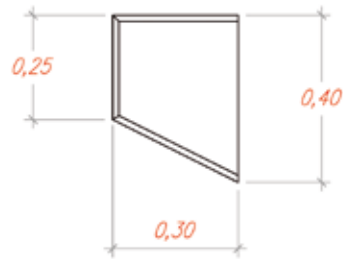
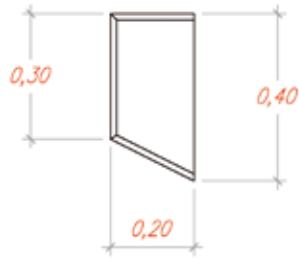
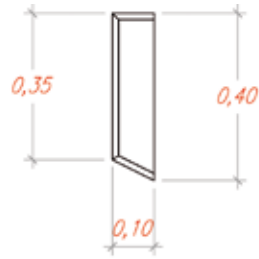
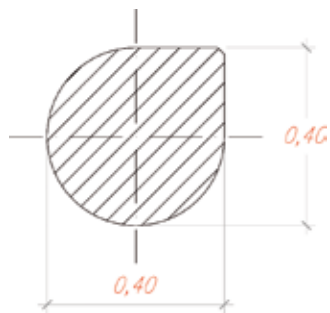

T
TECNYCONTA.
Prefabricados de hormigón

Oficinas Centrales y Fábrica

Carretera Gallur-Sangüesa, km. 11
50660 Tauste | Zaragoza
Teléfono: (+34) 976 869 750
Fax: (+34) 976 859 253

Delegación

Paseo Independencia 14, 1º izda.
50004 Zaragoza
Teléfono: (+34) 976 797 228
Fax: (+34) 976 797 284

tecnycnta@tecnycnta.com
www.tecnycnta.com



Grupo TÜV Rheinland